

REGISTER

Arkivskåp	4-7	Panoramamappar	14
Belysningramp	4	Pappershållare KlemFix	21
Beställningsblankett	2-3	Papperssamlare	18
Bordställ InfoFlex	27-29	Planeringspärm Val-Rex	31
Bordställ Zippel	13	Planeringstavlor Val-Rex	30-31
ColorTab bordställ	26	Plastfodral/plastfickor	18
ColorTab 0-9	24	Plastmappar	16,18
ColorTab A-Ö	24	Ramar InfoFlex A5, A4, A3	26-28
ColorTab färgetikett	25	Registerkort till mappar	19,21
ColorTab grundsats A-Ö	24	Ritningsförvaring/upph.remsor	21
Dagmarkeringssignaler	23	Röntgenficka	18
Etiketter/instick	14,17,20	Signaler självhäftande	22-24
Etiketthållare	14,20	Självhäftande plastfickor	14
Gallringssignaler, självhäftande	23	Sparring/Elfa väggskenor	11
Golvställning för mappar	13	Ståmappar A4L, A4S	14,15
Hylldelare	4,8,10	Ställning för mappar, portabel	12
Hyllplan, trä	4,7,10,12	Sökstickor	20
Hyllstegar/trähyllor	10	Tandläkarjournaler	18
Hängmappar Zippel	14	Tandstatusetiketter	18
Hängmappskena Zippel	4,7,9,11	T-kort Val-Rex	30-31
InfoFlex broschyrställ	27-29	Trähyllor/hyllstegar	9
InfoFlex ramar A5, A4, A3	27-29	Vakanskort Zippel	24
InfoFlex snabbregister	27-29	Väggarm Zippel	12
Inläggsmappar	16	Årtalsetiketter	22
Insticksetiketter	14,17,20	Ändbeslag Universal	12
Konsoler	11,12		
Kortbärare Val-Rex	31-32		
Mappar tvåpunkts	17		
Mappar, storformat	18		
Mappar/journalmappar	15-17		
Mappskena Zippel	3,6,8,10		
Metallhängare, offset	21		
Månadsmarkeringssignaler	22		

Huvudkontor: Scheelegatan 7, 212 28 MALMÖ
Tel 040-680 50 10 Fax 040-680 50 11

VAR VÄNLIG TEXTA!!

KUNDNUMMER







--	--	--	--	--	--	--	--	--	--

Fakturabetalare	Leveransmottagare
Utdelningsadress	Leveransadress
Postadress	Postadress
Best.ID, Refnr.	Telefonnummer
Mailadress	Kontaktperson



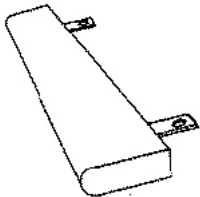

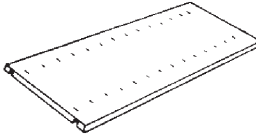
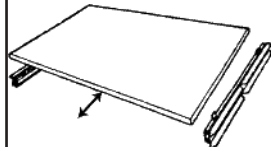

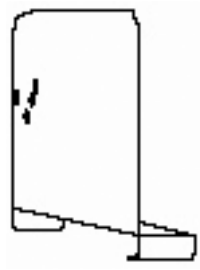
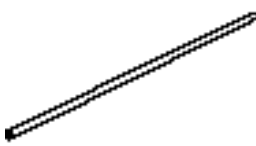

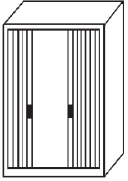

Varubeteckning	Best nr	Antal	à-pris	Summa
Ort, Datum	Namnteckning			

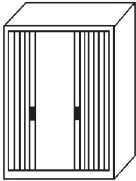

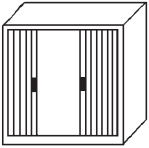

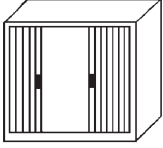
Vänligen kontrollera att Ni fyllt i namn, adress, varuslag och antal.



Fax nr 040-680 50 11 Faxa gärna in Er beställning eller sänd med post till adress enl ovan.

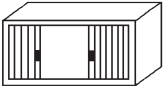

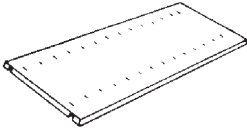

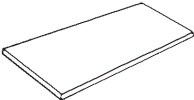
	Benämning	Bestnr	Pris												
	<p>STÅLSKÅP B 1970 mm höga för 6 Z-mappskenor Med låsbara sidgående rulljalousier av plastprofil. Utan inredning</p> <p>100 cm bredd Kapacitet 5,01 löpmeter Zippel hängmappar, format A4 L</p> <table border="0"> <tr> <td>Mått mm</td> <td>H</td> <td>B</td> <td>D</td> </tr> <tr> <td>Inv</td> <td>1895</td> <td>915</td> <td>440</td> </tr> <tr> <td>Utv</td> <td>1970</td> <td>1000</td> <td>470</td> </tr> </table> <p>Vikt 76 kg 1,02 m³</p> <p>Färg skåp/jalusi Beige/Vitt..... 8664 2001</p>	Mått mm	H	B	D	Inv	1895	915	440	Utv	1970	1000	470	3.955:-/st	
Mått mm	H	B	D												
Inv	1895	915	440												
Utv	1970	1000	470												
	<p>INREDNING TILL STÅLSKÅP B</p> <p>BELYSNINGSRAMP för journalskåp B-G-M Komplett med flimmerfritt 21 Watts lågenergi T-5 lysrör Motsvarar 200 Watt. Lysrörets brinntid ca 16.000 timmar</p> <p>Längd 900 mm Färg: vit..... 8662 6146</p>	1.495:-/st													
	<p>MAPPSKENA B med 2 konsoler för enpunktsupphängda Zippelmappar</p> <p>Mappskena 880 mm 8668 5031</p>	327:-/st													
	<p>HYLLPLAN B med upphängningskrokar</p> <p>Beige 915x390 mm..... 8664 3001</p>	259:-/st													
	<p>UTDRAGBART HYLLPLAN B på expansionsgejder</p> <p>Beige 815x405 mm..... 8664 3011</p>	652:-/st													
	<p>EXPANSIONSRAM B utdragbar för 2-punkts hängmappar, kortlådor eller arbetsskiva</p> <p>815x405 mm 8664 3211</p>	712:-/st													
 	<p>HYLLDELARE B passande hyllplan B. Hylldelare försedd med hål i bakkanten Röret träs genom och bakanslaget justeras härigenom att passa olika format, pärmar eller mappar (så att en rak framkant erhålles) Material: stål Färg: beige</p> <p>Höjd 205x395 mm 8664 3223</p> <p>Rör B till skjutbara hylldelare</p> <p>Längd 916 mm inkl plastproppar 8664 6010</p>	130:-/st 26:-/st													

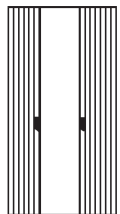

	Benämning	Bestnr	Pris													
	STÅLSKÅP M 1980 mm höga för 6 Z-mappskenor Med låsbara sidgående rulljalusier av obrännbar plastprofil. Utan inredning															
	120 cm bredd För Zippel hängmappar, storformat t. ex. 500x500 mm															
	<table border="0"> <tr> <td>Mått mm</td> <td>H</td> <td>B</td> <td>D</td> </tr> <tr> <td>Inv</td> <td>1875</td> <td>1070</td> <td>520</td> </tr> <tr> <td>Utv</td> <td>1980</td> <td>1200</td> <td>550</td> </tr> </table> Vikt 88 kg 1,44 m ³	Mått mm	H	B	D	Inv	1875	1070	520	Utv	1980	1200	550			
Mått mm	H	B	D													
Inv	1875	1070	520													
Utv	1980	1200	550													
	Färg skåp/jalusi Brunt/Beige 8662 0256*		7.765:-/st													
	120 cm bredd Kapacitet 6,24 löpmeter Zippel hängmappar, format A4 L															
	<table border="0"> <tr> <td>Mått mm</td> <td>H</td> <td>B</td> <td>D</td> </tr> <tr> <td>Inv</td> <td>1875</td> <td>1070</td> <td>420</td> </tr> <tr> <td>Utv</td> <td>1980</td> <td>1200</td> <td>450</td> </tr> </table> Vikt 82 kg 1,20 m ³	Mått mm	H	B	D	Inv	1875	1070	420	Utv	1980	1200	450			
Mått mm	H	B	D													
Inv	1875	1070	420													
Utv	1980	1200	450													
	Vitt/Vitt 8662 0033		7.465:-/st													
	100 cm bredd Kapacitet 5,04 löpmeter Zippel hängmappar, format A4 L															
	<table border="0"> <tr> <td>Mått mm</td> <td>H</td> <td>B</td> <td>D</td> </tr> <tr> <td>Inv</td> <td>1875</td> <td>870</td> <td>420</td> </tr> <tr> <td>Utv</td> <td>1980</td> <td>1000</td> <td>450</td> </tr> </table> Vikt 76 kg 0,81 m ³	Mått mm	H	B	D	Inv	1875	870	420	Utv	1980	1000	450			
Mått mm	H	B	D													
Inv	1875	870	420													
Utv	1980	1000	450													
	Vitt/Vitt 8662 0133		6.875:-/st													
	80 cm bredd Kapacitet 4,02 löpmeter Zippel hängmappar, format A4 L															
	<table border="0"> <tr> <td>Mått mm</td> <td>H</td> <td>B</td> <td>D</td> </tr> <tr> <td>Inv</td> <td>1875</td> <td>700</td> <td>420</td> </tr> <tr> <td>Utv</td> <td>1980</td> <td>800</td> <td>450</td> </tr> </table> Vikt 63 kg 0,78 m ³	Mått mm	H	B	D	Inv	1875	700	420	Utv	1980	800	450			
Mått mm	H	B	D													
Inv	1875	700	420													
Utv	1980	800	450													
	Vitt/Vitt 8662 0183*		6.350:-/st													
	60 cm bredd Kapacitet 2,82 löpmeter Zippel hängmappar, format A4 L															
	<table border="0"> <tr> <td>Mått mm</td> <td>H</td> <td>B</td> <td>D</td> </tr> <tr> <td>Inv</td> <td>1875</td> <td>500</td> <td>420</td> </tr> <tr> <td>Utv</td> <td>1980</td> <td>600</td> <td>450</td> </tr> </table> Vikt 52 kg 0,59 m ³	Mått mm	H	B	D	Inv	1875	500	420	Utv	1980	600	450			
Mått mm	H	B	D													
Inv	1875	500	420													
Utv	1980	600	450													
	Vitt/Vitt 8662 0163*		6.100:-/st													

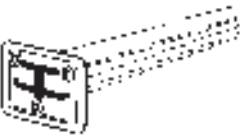
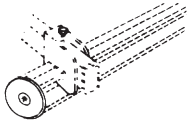
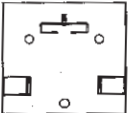
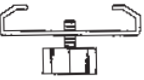

	Benämning	Bestnr	Pris												
	<p>STÅLSKÅP M 1252 mm höga för 4 Z-mappskenor Med låsbara sidgående rulljalousier av obrännbar plastprofil. Utan inredning</p> <p>100 cm bredd Kapacitet 3,36 löpmeter Zippel hängmappar, format A4 L</p> <table border="0"> <tr> <td>Mått mm</td> <td>H</td> <td>B</td> <td>D</td> </tr> <tr> <td>Inv</td> <td>1250</td> <td>870</td> <td>420</td> </tr> <tr> <td>Utv</td> <td>1252</td> <td>1000</td> <td>450</td> </tr> </table> <p>Vikt 47 kg 0,64 m³</p> <p>Färg skåp/jalusi Vitt/Vitt..... 8662 0633*</p>	Mått mm	H	B	D	Inv	1250	870	420	Utv	1252	1000	450	5.780:-/st	
Mått mm	H	B	D												
Inv	1250	870	420												
Utv	1252	1000	450												
	<p>120 cm bredd Kapacitet 4,16 löpmeter Zippel hängmappar, format A4 L</p> <table border="0"> <tr> <td>Mått mm</td> <td>H</td> <td>B</td> <td>D</td> </tr> <tr> <td>Inv</td> <td>1250</td> <td>1070</td> <td>420</td> </tr> <tr> <td>Utv</td> <td>1252</td> <td>1200</td> <td>450</td> </tr> </table> <p>Vikt 52 kg 0,77 m³</p> <p>Vitt/Vitt..... 8662 0433</p>	Mått mm	H	B	D	Inv	1250	1070	420	Utv	1252	1200	450	5.940:-/st	
Mått mm	H	B	D												
Inv	1250	1070	420												
Utv	1252	1200	450												
	<p>STÅLSKÅP M 952 mm höga för 3 Z-mappskenor Med låsbara sidgående rulljalousier av obrännbar plastprofil. Utan inredning</p> <p>100 cm bredd Kapacitet 2,52 löpmeter Zippel hängmappar, format A4 L</p> <table border="0"> <tr> <td>Mått mm</td> <td>H</td> <td>B</td> <td>D</td> </tr> <tr> <td>Inv</td> <td>950</td> <td>870</td> <td>420</td> </tr> <tr> <td>Utv</td> <td>952</td> <td>1000</td> <td>450</td> </tr> </table> <p>Vikt 41 kg 0,52 m³</p> <p>Vitt/Vitt..... 8662 0533</p>	Mått mm	H	B	D	Inv	950	870	420	Utv	952	1000	450	4.950:-/st	
Mått mm	H	B	D												
Inv	950	870	420												
Utv	952	1000	450												
	<p>120 cm bredd Kapacitet 3,12 löpmeter Zippel hängmappar, format A4 L</p> <table border="0"> <tr> <td>Mått mm</td> <td>H</td> <td>B</td> <td>D</td> </tr> <tr> <td>Inv</td> <td>950</td> <td>1070</td> <td>420</td> </tr> <tr> <td>Utv</td> <td>952</td> <td>1200</td> <td>450</td> </tr> </table> <p>Vikt 45 kg 0,62 m³</p> <p>Vitt/Vitt..... 8662 1033</p>	Mått mm	H	B	D	Inv	950	1070	420	Utv	952	1200	450	5.130:-/st	
Mått mm	H	B	D												
Inv	950	1070	420												
Utv	952	1200	450												
	<p>100 cm bredd för 1 Z-mappskena Kapacitet 0,84 löpmeter Zippel hängmappar, format A4 L</p> <table border="0"> <tr> <td>Mått mm</td> <td>H</td> <td>B</td> <td>D</td> </tr> <tr> <td>Inv</td> <td>498</td> <td>870</td> <td>420</td> </tr> <tr> <td>Utv</td> <td>500</td> <td>1000</td> <td>450</td> </tr> </table> <p>Vikt 35 kg</p> <p>Vitt/Vitt..... 8662 6031*</p>	Mått mm	H	B	D	Inv	498	870	420	Utv	500	1000	450	4.655:-/st	
Mått mm	H	B	D												
Inv	498	870	420												
Utv	500	1000	450												



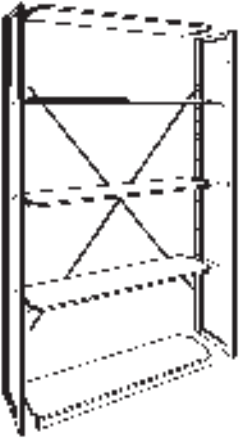
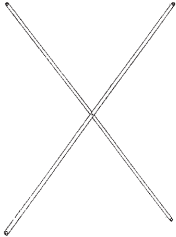
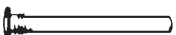

	Benämning	Bestnr	Pris
	<p>120 cm bredd för 1 Z-mappskåna Kapacitet 1,04 löpmeter Zippel hängmappar format A4 L</p> <p>Mått mm H B D Inv 498 870 420 Utv 500 1200 450 Vikt 37 kg Vitt/Vitt..... 8662 6030*</p>	8662 6030*	4.805:-/st 
	<p>INREDNING TILL STÅLSKÅP M Mappskåna M med 2 konsoler för enpunktsupphängda Zippelmappar</p> <p>För skåp 100 cmx45 cm djup Mappskåna 870 mm 8662 6100 120 cmx45 cm djup 1070 mm 8662 6228</p>	8662 6100 8662 6228	324:-/st 342:-/st
	<p>HYLLPLAN M med upphängningskrokar</p> <p>För skåp 100 cmx45 cm Vitt 870x375 mm 8663 6125 120 cmx45 cm Vitt 1070x375 mm..... 8663 6124 80 cmx45 cm Antracitgrått 705x375 mm 8662 6923</p>	8663 6125 8663 6124 8662 6923	310:-/st 325:-/st 277:-/st
	<p>HYLLPLAN M med utdragbar skiva 520x300 med upphängningskrokar</p> <p>För skåp 100 cmx45 cm Vitt 870x375 mm 8663 6129 120 cmx45cm Vitt 1070x375 mm..... 8663 6128</p>	8663 6129 8663 6128	603:-/st 616:-/st
 	<p>EXPANSIONSRAM M utdragbar för 2-punkts hängmappar, kortlådor och/eller arbetsskiva</p> <p>För skåp djup 450 mm 870x420 mm till 1000 mm skåp 8662 6775 1070x420 mm till 1200 mm skåp..... 8662 6774</p> <p>Arbetsskiva laminerad till expansionsram, heltäckande. Kan anpassas till önskad längd Ange ramens best nr..... 8662 6694</p> <p>*= beställningsvara</p>	8662 6775 8662 6774 8662 6694	1.599:-/st 1.657:-/st 583:-/st

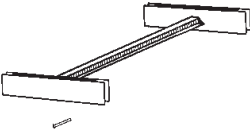
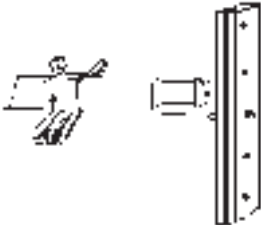
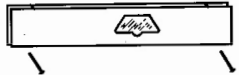

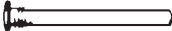
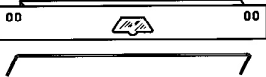

	Benämning	Bestnr	Pris
	<p>HYLLDELARE M passande hyllplan M. Hylldelaren försedd med hål i bakkanten. Röret träs genom och bakanslaget justeras härigenom att passa olika format, pärmar eller mappar (så att en rak framkant erhålles). Material: stål Färg: vit</p> <p>Höjd 270x375 mm 8662 6156</p>	8662 6156	125:-/st
 	<p>Rör M till skjutbara hylldelare</p> <p>Längd 1073 mm inkl plastproppar..... 8662 6152 873 mm inkl plastproppar..... 8662 6153</p> <p>Extra lås komplett med 2 nycklar..... 8662 6992</p>	8662 6152 8662 6153 8662 6992	30:-/st 24:-/st 347:-/st
	<p>Jalusidörrar M 1980 mm höjd Låsbara sidgående rulljalusier av obrännbar plastprofil Komplett sats v+h sida samt lås med 2 st nycklar</p> <p>100 cm bredd Vit..... 8662 6550 120 cm bredd Vit..... 8662 6555</p> <p>*= beställningsvara</p>	8662 6550 8662 6555	2.300:-/sts 2.630:-/sts

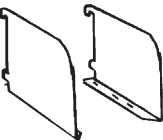

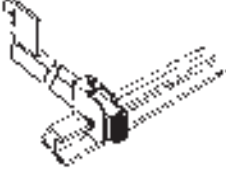

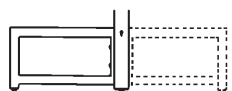
	Benämning	Bestnr	Pris																
	<p>MAPPSKENA Zippel standard för en-punkts Zippel hängmappar, från A4 till storformat Skenan kapas i önskad längd Max skenlängd mellan fästpunkter för A4 mappar, 1100 mm</p> <p>Exempel debitering</p> <table data-bbox="391 403 877 526"> <tr> <td>Längd</td> <td>850 mm</td> <td>-</td> <td>1 m</td> </tr> <tr> <td></td> <td>1067 mm</td> <td>-</td> <td>2 m</td> </tr> <tr> <td></td> <td>2 st x 1067 mm</td> <td>-</td> <td>3 m</td> </tr> <tr> <td></td> <td>10 st x 500 mm</td> <td>-</td> <td>5 m</td> </tr> </table> <p>Prisenhet i meter 8668 5017</p>	Längd	850 mm	-	1 m		1067 mm	-	2 m		2 st x 1067 mm	-	3 m		10 st x 500 mm	-	5 m	306:-/m	
Längd	850 mm	-	1 m																
	1067 mm	-	2 m																
	2 st x 1067 mm	-	3 m																
	10 st x 500 mm	-	5 m																
	<p>Mappskena Zippel förstärkt Höjd: 35 mm</p> <p>Prisenhet i meter 8668 5015</p>	418:-/m																	
 	<p>Fästbeslag till Zippel standard mappskena för montering i befintligt skåp eller på konsoler (nitas fast på skenan)</p> <p>Utv mått 58x45 mm 8668 5217</p> <p>Fastnitning fästbeslag 8668 5227</p> <p>Ändstopp av metall, rund (skruvas fast på skenan)</p> <p>Ø 35 mm 8668 5218</p> <p>Montering ändstopp..... 8668 5228</p>	22:-/st 17:-/st 14:-/st 14:-/st																	
  	<p>Fästbeslag till Zippel förstärkt mappskena för montering i skåp eller mellan två fästpunkter (fasthåller skenan med insexskruv) 8668 6423</p> <p>Ändstopp till Zippel förstärkt mappskena..... 8668 6422</p> <p>Gummihätta/skydd till Zippel förstärkt mappskena, svart..... 8668 6219</p> <p>*= beställningsvara</p>	43:-/st 20:-/st 6:-/st																	

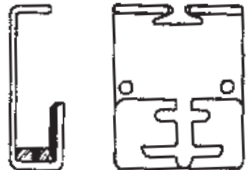
	Benämning	Bestnr	Pris	
	TRÄHYLLA Lundqvist/Lundia för Zippel mappsysteem i kombination med hyllplan Furu/klarlack			
	Hyllplan 800x300.....	8660 8030	142:-/st	
	1000x300.....	8660 1030	179:-/st	
	1200x300.....	8660 1230	268:-/st	
	Hyll- stege 1980x300.....	8660 1930	340:-/st	
	2080x300.....	8660 2030	354:-/st	
	2180x300.....	8660 2130	365:-/st	
	Hyllplan 800x400.....	8660 8040	179:-/st	
	1000x400.....	8660 1040	234:-/st	
	1200x400.....	8660 1240	294:-/st	
	Hyll- stege 1980x400.....	8660 1940	358:-/st	
	2080x400.....	8660 2040	371:-/st	
	2180x400.....	8660 2140	381:-/st	
	Önskas övriga storlekar - begär separat prisblad			
		Krysstag 800/1000.....	8660 9001	76:-/st
1200.....		8660 9002	79:-/st	
Sockel 65x800.....		8660 6580	57:-/st	
65x1000.....		8660 6510	69:-/st	
65x1200.....		8660 6512	78:-/st	
Gavelklämna		8660 1000	27:-/st	
Väggfäste		8660 4150	27:-/st	
 Sprint		8660 9004	1:40/st	
		HYLLDELARE skjutbar med ställbart hylldjup passande Lundqvist/Lundia eller Sparring/Elfa hyllplan Hylldelaren försedd med hål i bakkanten Röret träs genom och bakanslaget justeras härigenom att passa olika format, pärmar eller mappar (så att en rak framkant erhålles) Material: stål Färg: vit		
		Hylldelare 203x305 mm, skjutbar för hylldjup 300 mm Mått från hyllfront till hålserie: 245, 255, 265, 285 mm.....	8660 5030	148:-/st
	Hylldelare 203x405 mm, skjutbar för hylldjup 400 mm Mått från hyllfront till hålserie: 245, 255, 265, 315, 323, 385 mm.....	8660 5040	158:-/st	
*= beställningsvara				

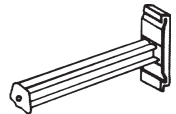
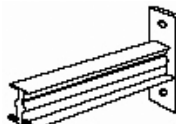
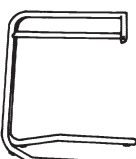

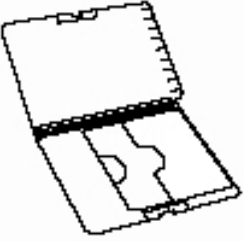
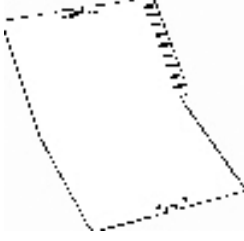

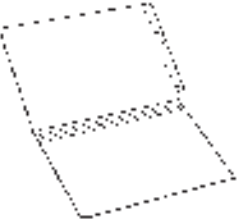
	Benämning	Bestnr	Pris
	<p>MAPPSKENA Zippel med konsoler För Lundqvist/Lundia trähyllor, exkl sprint</p> <p>800x300 mm 8668 0830 1000x300 mm 8668 1030 1200x300 mm 8668 1230 800x400 mm 8668 0840 1000x400 mm 8668 1040 1200x400 mm 8668 1240</p>		
	<p>KONSOLER FÖR ZIPPEL MAPPSKENOR Fyrkantrörkonsol med ändhakar och spänbygel till Lundqvist/Lundia trähyllor (konsol för hel obruten Z-skena genom flera sektioner)</p> <p>Hylldjup 400 mm Längd 306 mm 8668 0064</p>		
	<p>Konsol till Lundqvist/Lundia trähyllor För hylldjup 300 mm (asymmetriska) 8668 0132 För hylldjup 400 mm (centrerade) 8668 0142</p>		
	<p>Konsol till Lundqvist/Lundia trähyllor För hylldjup 500 mm, 443x50 mm 8668 0150 För hylldjup 600 mm, 543x50 mm 8668 0160</p>		
	<p>Sprint till Lundqvist/Lundia trähyllor 8660 9004</p>		
	<p>Konsol till Arkibra, Libra eller TreCe trähyllor För hylldjup 300 mm (asymmetriska) 8668 0236 För hylldjup 400 mm (centrerade) 8668 0246</p> <p>Trådbygel För hylldjup 400 mm 8668 0247</p>		

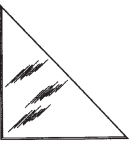
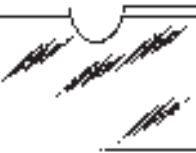
	Benämning	Bestnr	Pris																																																				
	SPARRING/ELFA väggskena och konsoler Färg: vit																																																						
	Väggskena																																																						
	<table border="0"> <thead> <tr> <th>Typ</th> <th>Längd mm</th> <th></th> <th></th> </tr> </thead> <tbody> <tr> <td>V 32</td> <td>316</td> <td>.....</td> <td>.8669 0132</td> </tr> <tr> <td>V 64</td> <td>636</td> <td>.....</td> <td>.8669 0164</td> </tr> <tr> <td>V 96</td> <td>956</td> <td>.....</td> <td>.869 0196</td> </tr> <tr> <td>V 160</td> <td>1596</td> <td>.....</td> <td>.8669 0160</td> </tr> <tr> <td>V 192</td> <td>1916</td> <td>.....</td> <td>.8669 0192</td> </tr> <tr> <td>V 224</td> <td>2236</td> <td>.....</td> <td>.8669 0224</td> </tr> </tbody> </table>	Typ	Längd mm			V 32	3168669 0132	V 64	6368669 0164	V 96	956869 0196	V 160	15968669 0160	V 192	19168669 0192	V 224	22368669 0224	<table border="0"> <tbody> <tr> <td></td> <td>39:-/st</td> </tr> <tr> <td></td> <td>61:-/st</td> </tr> <tr> <td></td> <td>83:-/st</td> </tr> <tr> <td></td> <td>108:-/st</td> </tr> <tr> <td></td> <td>135:-/st</td> </tr> <tr> <td></td> <td>174:-/st</td> </tr> </tbody> </table>		39:-/st		61:-/st		83:-/st		108:-/st		135:-/st		174:-/st	<table border="0"> <tbody> <tr> <td></td> <td>39:-/st</td> </tr> <tr> <td></td> <td>61:-/st</td> </tr> <tr> <td></td> <td>83:-/st</td> </tr> <tr> <td></td> <td>108:-/st</td> </tr> <tr> <td></td> <td>135:-/st</td> </tr> <tr> <td></td> <td>174:-/st</td> </tr> </tbody> </table>		39:-/st		61:-/st		83:-/st		108:-/st		135:-/st		174:-/st
Typ	Längd mm																																																						
V 32	3168669 0132																																																				
V 64	6368669 0164																																																				
V 96	956869 0196																																																				
V 160	15968669 0160																																																				
V 192	19168669 0192																																																				
V 224	22368669 0224																																																				
	39:-/st																																																						
	61:-/st																																																						
	83:-/st																																																						
	108:-/st																																																						
	135:-/st																																																						
	174:-/st																																																						
	39:-/st																																																						
	61:-/st																																																						
	83:-/st																																																						
	108:-/st																																																						
	135:-/st																																																						
	174:-/st																																																						
	Väggskena förstärkt																																																						
	<table border="0"> <thead> <tr> <th>Typ</th> <th>Längd mm</th> <th></th> <th></th> </tr> </thead> <tbody> <tr> <td>W 120</td> <td>1200</td> <td>.....</td> <td>.8669 0230</td> </tr> <tr> <td>W 200</td> <td>2145</td> <td>.....</td> <td>.8669 0240</td> </tr> </tbody> </table>	Typ	Längd mm			W 120	12008669 0230	W 200	21458669 0240	<table border="0"> <tbody> <tr> <td></td> <td>234:-/st</td> </tr> <tr> <td></td> <td>317:-/st</td> </tr> </tbody> </table>		234:-/st		317:-/st	<table border="0"> <tbody> <tr> <td></td> <td>234:-/st</td> </tr> <tr> <td></td> <td>317:-/st</td> </tr> </tbody> </table>		234:-/st		317:-/st																																
Typ	Längd mm																																																						
W 120	12008669 0230																																																				
W 200	21458669 0240																																																				
	234:-/st																																																						
	317:-/st																																																						
	234:-/st																																																						
	317:-/st																																																						
	Konsol för hyllplan																																																						
	<table border="0"> <thead> <tr> <th>Typ</th> <th>Längd mm</th> <th></th> <th></th> </tr> </thead> <tbody> <tr> <td>K 27</td> <td>270</td> <td>.....</td> <td>.8669 0027</td> </tr> <tr> <td>K 37</td> <td>370</td> <td>.....</td> <td>.8669 0037</td> </tr> <tr> <td>K 47</td> <td>470</td> <td>.....</td> <td>.8669 0047</td> </tr> </tbody> </table>	Typ	Längd mm			K 27	2708669 0027	K 37	3708669 0037	K 47	4708669 0047	<table border="0"> <tbody> <tr> <td></td> <td>22:-/st</td> </tr> <tr> <td></td> <td>33:-/st</td> </tr> <tr> <td></td> <td>43:-/st</td> </tr> </tbody> </table>		22:-/st		33:-/st		43:-/st	<table border="0"> <tbody> <tr> <td></td> <td>22:-/st</td> </tr> <tr> <td></td> <td>33:-/st</td> </tr> <tr> <td></td> <td>43:-/st</td> </tr> </tbody> </table>		22:-/st		33:-/st		43:-/st																								
Typ	Längd mm																																																						
K 27	2708669 0027																																																				
K 37	3708669 0037																																																				
K 47	4708669 0047																																																				
	22:-/st																																																						
	33:-/st																																																						
	43:-/st																																																						
	22:-/st																																																						
	33:-/st																																																						
	43:-/st																																																						
	Gavelkonsol för hyllplan (Ange om par V + H)																																																						
	<table border="0"> <thead> <tr> <th>Typ</th> <th>Längd mm</th> <th></th> <th></th> </tr> </thead> <tbody> <tr> <td>GA 30</td> <td>300</td> <td>.....</td> <td>.8669 0030</td> </tr> <tr> <td>GA 40</td> <td>400</td> <td>.....</td> <td>.8669 0040</td> </tr> </tbody> </table>	Typ	Längd mm			GA 30	3008669 0030	GA 40	4008669 0040	<table border="0"> <tbody> <tr> <td></td> <td>79:-/st</td> </tr> <tr> <td></td> <td>84:-/st</td> </tr> </tbody> </table>		79:-/st		84:-/st	<table border="0"> <tbody> <tr> <td></td> <td>79:-/st</td> </tr> <tr> <td></td> <td>84:-/st</td> </tr> </tbody> </table>		79:-/st		84:-/st																																
Typ	Längd mm																																																						
GA 30	3008669 0030																																																				
GA 40	4008669 0040																																																				
	79:-/st																																																						
	84:-/st																																																						
	79:-/st																																																						
	84:-/st																																																						
	Hyllplan kantlistat, vitt																																																						
	<table border="0"> <tbody> <tr> <td>900x300 mm</td> <td>.....</td> <td>.8669 0031</td> <td>103:-/st</td> </tr> <tr> <td>1800x300 mm</td> <td>.....</td> <td>.8669 0061</td> <td>244:-/st</td> </tr> <tr> <td>900x400 mm</td> <td>.....</td> <td>.8669 0041</td> <td>142:-/st</td> </tr> </tbody> </table>	900x300 mm8669 0031	103:-/st	1800x300 mm8669 0061	244:-/st	900x400 mm8669 0041	142:-/st	<table border="0"> <tbody> <tr> <td></td> <td>103:-/st</td> </tr> <tr> <td></td> <td>244:-/st</td> </tr> <tr> <td></td> <td>142:-/st</td> </tr> </tbody> </table>		103:-/st		244:-/st		142:-/st	<table border="0"> <tbody> <tr> <td></td> <td>103:-/st</td> </tr> <tr> <td></td> <td>244:-/st</td> </tr> <tr> <td></td> <td>142:-/st</td> </tr> </tbody> </table>		103:-/st		244:-/st		142:-/st																												
900x300 mm8669 0031	103:-/st																																																				
1800x300 mm8669 0061	244:-/st																																																				
900x400 mm8669 0041	142:-/st																																																				
	103:-/st																																																						
	244:-/st																																																						
	142:-/st																																																						
	103:-/st																																																						
	244:-/st																																																						
	142:-/st																																																						
	KONSOLER för Zippel mappskena passande Sparring/Elfa och Pelly väggskenor För kombination väggskena/Zippel mappskena																																																						
	Konsol för A4-folioformat																																																						
	Längd 200 mm8668 0023	.8668 0023	55:-/st																																																				
	Konsol med spännbygel för mappar A4-A2																																																						
	Max bredd på mappen 550 mm Längd 300 mm, flexibel8668 0030	.8668 0030	115:-/st																																																				
	Konsol med spännbygel för storformatsmappar																																																						
	Max bredd på mappen 940 mm Längd 490 mm, flexibel, förstärkt8668 0050	.8668 0050	174:-/st																																																				
	Extra spännbygel..... .8668 0032	.8668 0032	36:-/st																																																				

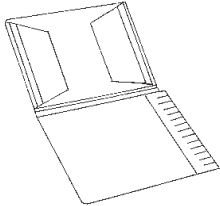
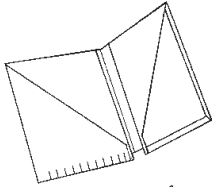
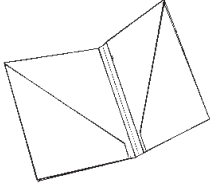
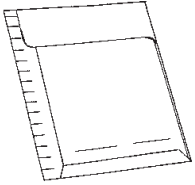
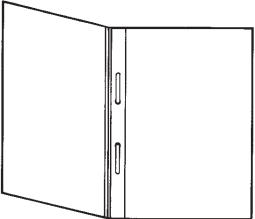
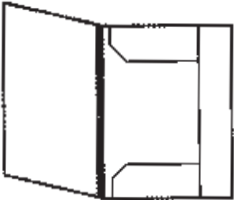

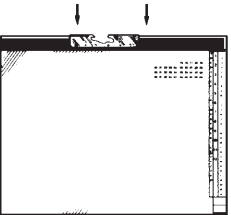
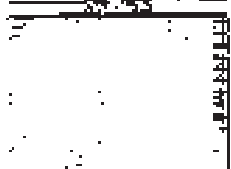
	Benämning	Bestnr	Pris																
   	<p>GOLVSTÄLLNING för Zippelskenor/hyllplan för kombination mappskena/hyllplan Färg: vit</p> <p>Ständare Höjd mm. Profilmått 45x25</p> <p>DS 2 1800 8669 1800* 509:-/st DS 2 2000 8669 2000* 532:-/st</p> <p>Fot till ständare DS 2 för dubbelsidig ställning, 2 st per ständare</p> <p>Typ Längd mm</p> <p>SKF 25 250 8669 1025* 211:-/st SKF 40 400 8669 1040* 229:-/st</p> <p>Mellanstag Två st per sektion</p> <p>Typ Längd mm</p> <p>Z 90 c-c 900 mm 875 mm 8669 2090* 183:-/st Z 90-1 c-c 885 mm 860 mm 8669 2091* 180:-/st</p> <p>Hjul Höjd 100 mm 4 st/sats 8669 2250* 628:-/sts Zippel mappskena/konsoler se sid 10 resp 14</p>																		
 	<p>UNIVERSAL I Zippel för mappskena Zippel standard 668 5017</p> <table border="1"> <thead> <tr> <th>Mått mm</th> <th>Höjd</th> <th>Bredd</th> <th>Djup</th> </tr> </thead> <tbody> <tr> <td>Utv</td> <td>63</td> <td>50</td> <td>18</td> </tr> </tbody> </table> <p>(Höjd till mappskenans underkant 55 mm) 8668 5220 70:-/st</p> <p>UNIVERSAL II Zippel För mappskena Zippel förstärkt 668 5015</p> <table border="1"> <thead> <tr> <th>Mått mm</th> <th>Höjd</th> <th>Bredd</th> <th>Djup</th> </tr> </thead> <tbody> <tr> <td>Utv</td> <td>70</td> <td>60</td> <td>18</td> </tr> </tbody> </table> <p>(Höjd till mappskenans underkant 65 mm) 8668 5221 105:-/st</p>	Mått mm	Höjd	Bredd	Djup	Utv	63	50	18	Mått mm	Höjd	Bredd	Djup	Utv	70	60	18		
Mått mm	Höjd	Bredd	Djup																
Utv	63	50	18																
Mått mm	Höjd	Bredd	Djup																
Utv	70	60	18																
 	<p>VÄGGARM Zippel Material: aluminium (monteras direkt på vägg)</p> <p>Längd 80 mm 8615 6117 125:-/st</p> <p>Väggarm Zippel förstärkt Lämplig för storformatsmappar typ: reklambyråer, tryckerier och liknande</p> <p>Längd 150 mm 8615 6120 193:-/st Längd 260 mm 8615 6121 211:-/st</p>																		
	<p>BORDSTÄLL Zippel A4 för Zippel hängmappar. Material: stålror Färg: antikvitt</p> <table border="1"> <thead> <tr> <th>Mått mm</th> <th>Längd</th> <th>Bredd</th> <th>Höjd</th> </tr> </thead> <tbody> <tr> <td>Utv</td> <td>320</td> <td>290</td> <td>370</td> </tr> </tbody> </table> <p>Mappskenans längd 285 mm 8668 1026 415:-/st</p>	Mått mm	Längd	Bredd	Höjd	Utv	320	290	370										
Mått mm	Längd	Bredd	Höjd																
Utv	320	290	370																

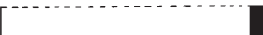

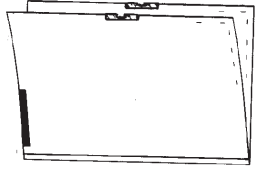
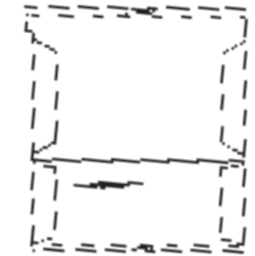
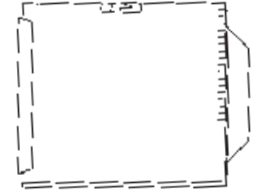
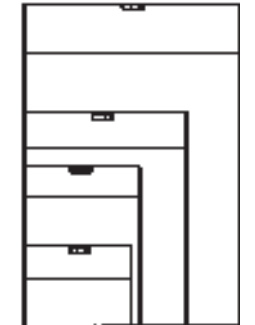
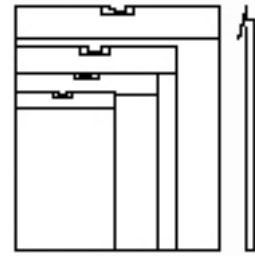

	Benämning	Bestnr	Pris
	<p>PANORAMA HÄNGMAPPSYSTEM</p> <p>A4 L hängmapp/journalmapp 320 g gulbeige kartong, laminerad utv, markering för ColorTab färgsignaler Överlappad framkant höger sida, 2 separata A5 fickor varav en med slits för OPG Kam för infästning av journalblad (skapar en bläddringsfunktion) Bottenkapacitet 20 mm</p> <p>Utv 330/312x246 mm 80 st/fp 8668 0828</p>	8668 0828	15:50/st
	<p>A4 L hängmapp/journalmapp som ovan men utan tillbehör</p> <p>Utv 330/312x246 mm 100 st/fp 8668 0817</p>	8668 0817	7:50/st
	<p>PANORAMA MAPPSYSTEM</p> <p>A4 L ståmapp/journalmapp 320 g gulbeige kartong, markering för ColorTab färgsignaler Överlappad framkant höger sida, 2 fickor vänster sida (A4+A5). Kam för infästning av journalblad (skapar en bläddringsfunktion) Bottenkapacitet 20 mm</p> <p>Utv 326/304x237 mm 100 st/fp 8144 0925</p>	8144 0925	10:50/st
	<p>A4 L ståmapp/journalmapp som ovan men utan tillbehör</p> <p>Utv 326/304x237 mm 100 st/fp 8144 0914</p>	8144 0914	4:50/st
  	<p>TILLBEHÖR</p> <p>Kam för inklistring i ståmapp/hängmapp (Skapar en bläddringsfunktion) Antal flikar: 44 st</p> <p>Längd 280 mm 100 st/fp 8668 1011</p> <p>Snedficka transparent självhäftande för inklistring i ståmapp/hängmapp</p> <p>Utv 170x170 mm 100 st/fp 8665 2335</p> <p>Röntgenficka transparent självhäftande med tumgrepp. 1 långsida öppen För inklistring i ståmapp/hängmapp</p> <p>Utv 225x145 mm 100 st/fp 8665 2329</p>	8668 1011 8665 2335 8665 2329	1:30/st 2:50/st 3:95/st

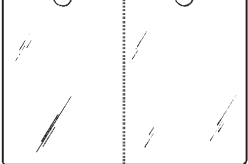
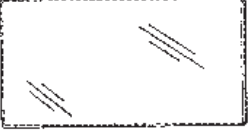
	Benämning	Bestnr	Pris
	<p>JOURNALMAPPAR - STÅMAPPAR A4 L – A4 S med tryck för ColorTab Datumssystem 1–31/1–12</p> <p>Brun kartong</p> <p>A4 Liggande Dubbel, med 2 klaffar, tryck 1–12 Utv 332/315x255 mm 175 st/fp..... 8144 0408</p>	6:50/st	
	<p>A4 Liggande Dubbel, med 2 snedfickor, tryck 1–12 Utv 315x243/234 mm 250 st/fp..... 8144 0410</p>	7:50/st	
	<p>A4 Stående Dubbel, med 2 snedfickor, tryck 1–12 Utv 260/240x320 mm 275 st/fp..... 8144 0416</p>	7:50/st	
	<p>A4 Stående Enkel, med utstansning upptill för person/patientuppgifter samt tryck 1–12 Utv 260/240x320 mm 525 st/fp..... 8144 0426</p>	5:50/st	
	<p>INLÄGGSMAPPAR och STÅMAPPAR</p> <p>Inläggsmapp A4 med låsstrimla 290 g kartong ..01 grön ..02 gul ..04 orange ..05 röd ..06 blå ..17 brun ..19 beige Utv 305x230 mm 25 st/fp 8144 07..</p> <p>Inläggsmapp A4 utan låsstrimla 290 g kartong ..01 grön ..02 gul ..04 orange ..05 röd ..06 blå ..17 brun ..19 beige Utv 305x230 mm 25 st/fp 8144 08..</p>	5:40/st	
	<p>3-klaffsmapp A3 Utv 310x430 mm 50 st/fp 8144 6233</p> <p>3-klaffsmapp A2 Utv 430x620 mm 50 st/fp 8144 6232</p>	15:-/st	23:-/st

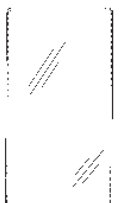
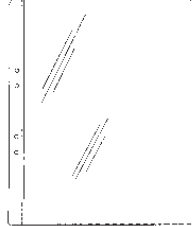



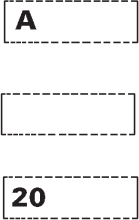
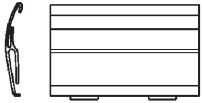

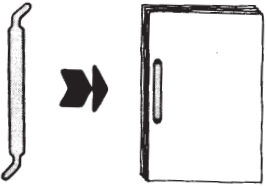
	Benämning	Bestnr	Pris
	<p>JOURNALMAPPAR Zippel A4 transp Plastficka med 1 öppen kortsida</p> <p>Polyetenplast Fönster för insticksetikett. Förskjutet bleck 250 st/fp (Endast hel fp)</p> <p>Med blått tryck 1-31, 1-12, A-Ö Utv 315x250 mm 8668 6215</p> <p>Utan tryck..... 8668 6216</p>		
 	<p>Glasklar plast Fönster för insticksetikett 150 st/fp (Endast hel fp)</p> <p>Med blått tryck 1-31, A-Ö Utv 313x250 mm 8668 6251</p> <p>Med blått tryck 1-31, A-Ö + Æ, Ø, Å + ColorTab färgsignaler Utv 313x260 mm 8668 6233</p> <p>Med blått tryck 1-31, A-Ö, förskjutet bleck Utv 313x250 mm 8668 6261</p>		
 	<p>Insticksetiketter vita. Perforerade ark för utskrift på skrivmaskin. För transparenta mappar med best nr 668 6233 (51, 61) 103x12 mm 500 st/fp..... 8668 5208</p> <p>Insticksetiketter vita. Perforerade ark för utskrift på skrivmaskin. För transparenta mappar med best nr 668 6215 110x15 mm 500 st/fp..... 8668 4908 71x15 mm 504 st/fp 8668 5108</p>		
	<p>ABA-Zett A4 transparent skena av fiber</p> <p>Utv 315x250 mm 100 st/fp..... 8666 3914</p>		

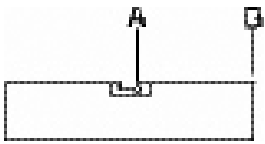



	Benämning	Bestnr	Pris																												
	<p>STORFORMATSMAPPAR Storformat 300 g brun kartong, 1 vävveck i bakkant, förstärkt botten Stansad för etikethållare. Bottenkapacitet 20 mm</p> <p>Utv 410x290 mm 60 st/fp..... 8668 5084</p>	8668 5084	16:90/st																												
	<p>Storformat A2 300 g brun kartong, 1 vävveck i bakkant, stansad för etikethållare. Bottenkapacitet 20 mm</p> <p>Utv 650x460 mm 20 st/fp..... 8668 5082</p>	8668 5082	38:00/st																												
	<p>Storformat 340 g brun kartong med flik samt 4 klaffar Bottenkapacitet 20 mm</p> <p>Utv 696x600 mm 20 st/fp..... 8668 5188</p>	8668 5188	40:00/st																												
	<p>Storformat 300 g brun kartong, öppen en kortsida framtill Med klaff, markering för ColorTab färgsignaler Bottenkapacitet 20 mm</p> <p>Utv 460x400 mm 60 st/fp..... 8668 4000</p>	8668 4000	17:00/st																												
	<p>Storformat toppmatad 250 g brun kartong för originalförvaring 1 ficka med dammskyddande klaff</p> <table border="0"> <tr> <td>Totalmått</td> <td>Materialmått</td> <td></td> <td></td> </tr> <tr> <td>Bredd Höjd</td> <td>Bredd Höjd</td> <td></td> <td></td> </tr> <tr> <td>395x 305 mm</td> <td>390x 275 mm</td> <td>100 st/fp.....</td> <td>8668 5686</td> </tr> <tr> <td>395x 575 mm</td> <td>390x 545 mm</td> <td>20 st/fp.....</td> <td>8668 5687</td> </tr> </table>	Totalmått	Materialmått			Bredd Höjd	Bredd Höjd			395x 305 mm	390x 275 mm	100 st/fp.....	8668 5686	395x 575 mm	390x 545 mm	20 st/fp.....	8668 5687	8668 5686 8668 5687	12:90/st 21:00/st												
Totalmått	Materialmått																														
Bredd Höjd	Bredd Höjd																														
395x 305 mm	390x 275 mm	100 st/fp.....	8668 5686																												
395x 575 mm	390x 545 mm	20 st/fp.....	8668 5687																												
	<p>Storformat toppmatad 250 g brun kartong för fotomontage och offsetplåt 2 fickor med dammskyddande klaff över 1 ficka Påtryckta markeringar för Color-Tab färgsignaler samt ruta för jobbschema</p> <table border="0"> <tr> <td>Totalmått</td> <td>Materialmått</td> <td></td> <td></td> </tr> <tr> <td>Bredd Höjd</td> <td>Bredd Höjd</td> <td></td> <td></td> </tr> <tr> <td>275x440 mm</td> <td>255x390 mm</td> <td>50 st/fp.....</td> <td>8668 5644</td> </tr> <tr> <td>390x500 mm</td> <td>370x450 mm</td> <td>50 st/fp.....</td> <td>8668 5645</td> </tr> <tr> <td>440x570 mm</td> <td>420x520 mm</td> <td>50 st/fp.....</td> <td>8668 5646</td> </tr> <tr> <td>570x700 mm</td> <td>550x650 mm</td> <td>50 st/fp.....</td> <td>8668 5647</td> </tr> <tr> <td>640x800 mm</td> <td>620x750 mm</td> <td>50 st/fp.....</td> <td>8668 5648</td> </tr> </table>	Totalmått	Materialmått			Bredd Höjd	Bredd Höjd			275x440 mm	255x390 mm	50 st/fp.....	8668 5644	390x500 mm	370x450 mm	50 st/fp.....	8668 5645	440x570 mm	420x520 mm	50 st/fp.....	8668 5646	570x700 mm	550x650 mm	50 st/fp.....	8668 5647	640x800 mm	620x750 mm	50 st/fp.....	8668 5648	8668 5644 8668 5645 8668 5646 8668 5647 8668 5648	17:00/st 23:00/st 27:00/st 48:00/st 61:00/st
Totalmått	Materialmått																														
Bredd Höjd	Bredd Höjd																														
275x440 mm	255x390 mm	50 st/fp.....	8668 5644																												
390x500 mm	370x450 mm	50 st/fp.....	8668 5645																												
440x570 mm	420x520 mm	50 st/fp.....	8668 5646																												
570x700 mm	550x650 mm	50 st/fp.....	8668 5647																												
640x800 mm	620x750 mm	50 st/fp.....	8668 5648																												

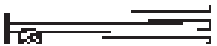

	Benämning	Bestnr	Pris
	RÖNTGENFICKA 2xA5, glasklar plast till journalmapp 668 62..(01-15), (33), (51). A4 format Utv 305x210 mm 100 st/fp.....	8665 2326	3:10/st
	Röntgenficka OPG, glasklar plast Utv 310/305x160 mm 100 st/fp.....	8665 2354	3:10/st
	JURNALER/BLANKETTER A4 format för tandläkare, grönt tryck Basjournaler 100 st/fp 8609 0621 8609 0623 8609 0624 8609 0626 8609 0628 8619 0032 Barn- och ungdomsjournal 8609 0617 Tillägsblad, Barn- och ungdomsjournal 8609 0615 Fortsättnings- och Daganteckningsjournal 100 st/fp 8609 0616 8609 0622 8609 0625 8609 0627 8609 0629 Tandstatusjournal, 2-sidig 8619 0036 Tandstatusetiketter, självhäftande 300 st/fp..... 8609 0603	219:-/fp 219:-/fp 219:-/fp 219:-/fp 219:-/fp 219:-/fp 219:-/fp 219:-/fp 219:-/fp 219:-/fp 219:-/fp 219:-/fp 385:-/fp	
	Plastfodral A4 format med tumgrepp, öppen 2 sidor, 0,15 mm plast ..01 grön ..02 gul.. 05 röd ..06 blå ..45 glasklar Utv 222/212x310/302 mm 100 st/fp.....	8665 18..	2:-/st
	Plastfodral A5+ öppen 1 kortsida. Utv 217/212x160 mm 100 st/fp..... 8665 2305 Dito öppen 1 kortsida. Utv 98x128/124 mm 8665 2309	8665 2305 8665 2309	2:20/st 2:-/st
	Plastfodral A5+ öppen i kortsida + långsida. Utv 155x216 mm 100 st/fp.....	8665 2316	2:-/st

	Benämning	Bestnr	Pris
	<p>REGISTERKORT Zippel A4 av svart konstläderkartong för A4 mappformat Flyttbar etikethållare samt instick ingår</p> <p>Passar för A4 mapp 8668 6233, 51 Instick 1-31, A-Ö. A-B mått 150 mm</p> <p>312x120 mm Hel sats 35 st/fp 8668 3147 397:-/fp Med neutrala instick</p> <p>312x120 mm 10 st/fp 8668 3146 14:90/st</p>		
	<p>Registerkort Zippel A4 förskjutet bleck för A4 transparent mapp 668 6215, 61</p> <p>Instick 1-31, A-Ö. A-B mått 163 mm</p> <p>312x120 mm Hel sats 35 st/fp 8668 4147 397:-/fp Med neutrala instick</p> <p>312x120 mm 10 st/fp 8668 4146 14:90/s</p>		
	<p>Instick till etikethållare</p> <p>Vita otryckta 100 st /fp 8666 3506 51:-/fp A-Ö, 1-31, liggande/stående text</p> <p>Vita Sats 8666 3530 46:-/fp Jan-Dec, 1-12, liggande/stående text</p> <p>Vita Sats 8666 3512 23:-/fp 1-52, liggande/stående text</p> <p>Vita Sats 8666 3553 37:-/f</p>		
	<p>ETIKETHÅLLARE/INSTICKSETIKETTER Etikethållare transparent hårdplast Längd 58 mm, bredd 16 mm 100 st/fp 8666 3306 1:60/st</p>		
	<p>PAPPERSSAMLARE för gruppering av hålslaget material</p> <p>Flax A4 med plastöverdragen häftstrimla 70 mm hålavstånd, svensk standard 100 st/fp 8666 3001 2:90/st</p>		
	<p>Foam Clip självhäftande Utv 170x18 mm 100 st/fp 8666 3003 2:10/st</p>		
	<p>Meg Clip plast Utv 100x7 mm vit, svensk standard 100 st/fp 8666 3007 36:-/fp</p>		

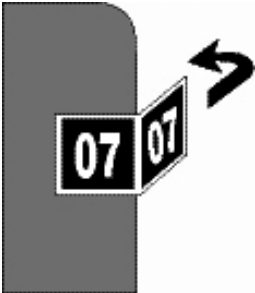

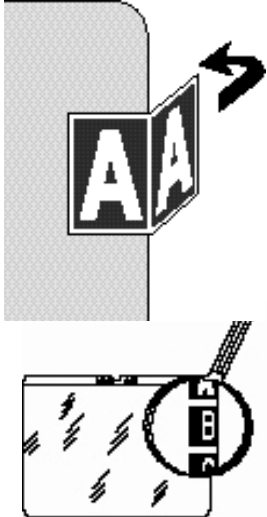

	Benämning	Bestnr	Pris
 <p>A-B mått, se sid 60</p>	<p>SÖKSTICKA/MARKÖR av kartong för transparenta journalmappar. Med upphängningsbleck För markering av uttagen journal/akt</p> <p>Söksticka/markör I Bildar upphängd rak frontkant med mappserie 668 62..(33-80) (Passar att förvaras inuti ovanstående mappserie) A-B mått 149 mm. Färg: röd</p> <p>305x75 mm 50 st/fp..... 8668 5605</p>		225:-/fp
	<p>Söksticka/markör II Bildar upphängd rak frontkant med mappserie 668 62..(01-16). Sticker upphängd 15 mm utanför frontkanten på mappserie 668 62..(33-80)</p> <p>A-B mått 165 mm ..03 rosa ..05 röd ..07 blå</p> <p>Ange färgnr i best nr 305x75 mm 50 st/fp..... 8668 59..</p>		225:-/fp
	<p>Söksticka/markör III Sticker upphängd 15 mm utanför frontkanten på mappserie 668 62..(01-16). Färg: röd</p> <p>A-B mått 180 mm 305x75 mm 50 st/fp..... 8668 5705</p>		225:-/fp
<p>Söksticka</p>	<p>Söksticka/markör för transparenta journalmappar 668 62..(33, 51-69) Sticker 15 mm utanför mappen</p> <p>..01 grön ..02 gul ..03 rosa ..04 orange ..05 röd ..06 blå ..08 vit ..11 svart ..17 brun ..18 beige</p> <p>Ange färgnr i best nr 319x75 mm 50 st/fp..... 8668 70..</p> <p>För transparenta journalmappar 668 62..(01-16) 324x75 mm 50 st/fp..... 8668 71..</p> <p>För journalmapp Panorama 144 0925, 668 0828 ..01 grön ..02 gul ..04 orange ..05 röd ..06 blå</p> <p>333x75 mm 50 st/fp..... 8668 73..</p>		97:-/fp 98:-/fp 99:-/fp

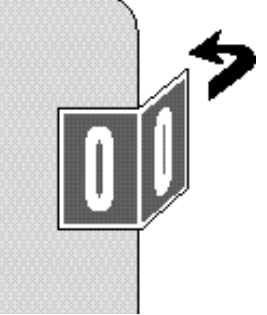

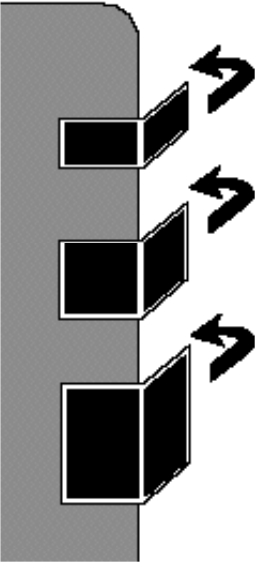
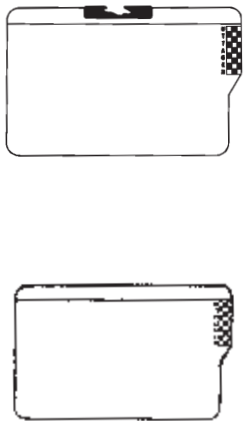

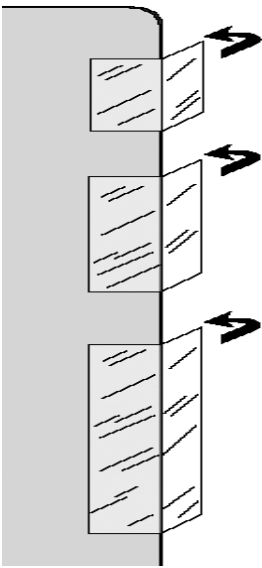
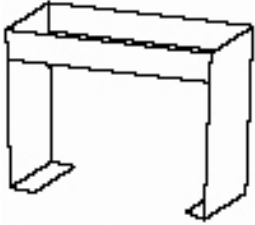
	Benämning	Bestnr	Pris
	<p>REGISTERKORT Zippel Ritningsförvaring Flyttbar etikethållare samt neutrala instick ingår</p> <p>Format Mått</p> <p>A3 340x150 mm 10 st/fp..... 8615 6131</p> <p>A0 880x200 mm 10 st/fp..... 8615 6134</p>		
	<p>Upphängningsremsa Zippel för originalritningar Självhäftande remsa av prespankartong med plastförstärkt upphängning</p> <p>Format Längd Bredd Tjocklek</p> <p>A4 240 48 0,5 mm 100 st/fp..... 8615 6305</p>		
	<p>Upphängningsremsa EP för ritningskopior/kartor Remsa av dubbelvikt kartong, upphängning av metall Materialet fastsättes i dubbelremsan med häftapparat</p> <p>Format Längd Bredd</p> <p>A3 315 mm 55 mm 25 st/fp..... 8615 6103</p>		
	<p>Metallhängare Zippel Offset för håslagna offsetplåtar som fastsättes med plastad metallstrimla</p> <p>Utv 100x35 mm 100 st/fp 8668 5775</p>		
	<p>Upphängningstillbehör för ritnings-skåp av gaffeltyp. Passar till Fackman, Möbus och Bode Panzer ritnings-skåp. Vit plast, självhäftande</p> <p>Håldelning 130+130+130 mm osv, (10 mm självhäftande) Bredd: 55 mm 50 m/rulle 8468 1550</p>		
  	<p>Ritnings- och pappershållare Klemfix av plast, 33x42 mm, självhäftande</p> <p>Ljusgrå 10 st/fp 8112 1429</p> <p>Klemfix skjutbar på skena Brun/vit 30x30 mm 10 st/fp 8112 0113</p> <p>Klemfixskena 1.000x20 mm</p> <p>Lättmetall 10 st/fp 8112 2115</p> <p>Plast 10 st/fp 8112 0115</p>		

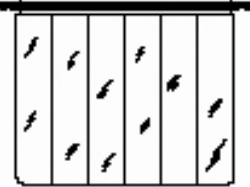



	Benämning	Bestnr	Pris
	<p>Dagmarkeringssignaler ColorTab för markering på mappar/journaler och liknande Självhäftande</p> <p>..01 grön ..02 gul ..03 rosa ..05 röd ..07 blå</p> <p>45x6 mm 36 st/remsa 504 st/fp..... 8902 78..</p>		178:-/fp
	<p>Gallringssignaler ColorTab med årtalstryck för utgallring av mappar/journaler och liknande Självhäftande</p> <p>..00 svart ..01 röd ..02 blå ..03 gul ..04 grön ..05 svart ..06 röd ..07 blå</p> <p>45x6 mm 36 st/remsa 504 st/fp..... 8902 16.. Ange årtal i best nr (Finns även med andra årtal)</p>		189:-/fp
	<p>Månadsmarkeringssignaler ColorTab för markering på mappar/journaler och liknande Självhäftande</p> <p>..01 grön ..02 gul ..03 rosa ..04 orange ..05 röd ..07 blå ..08 vit ..09 grå ..11 svart ..13 m grön ..14 lila ..16 lindgrön ..17 brun ..24 guld</p> <p>38x12,7 mm 1000 st/rulle 8912 35.. Ange färgnr i best nr</p>		249:-/rl
	<p>Årtalsfärgetikett för vertikal applikation på akter/mappar Markerar t.ex. senaste besöksår. 10 cirkulerande färger Höjd 19 mm Med årtalstryck</p> <p>..05 guld ..06 mörkgrön ..07 mörkblå ..08 orange ..09 svart ..10 gul</p> <p>1000 st/rulle 8911 17..</p>		285:-/rl
	<p>Årtalsfärgetikett för horisontell applikation på akter/mappar Markerar t.ex. senaste besöksår. 10 cirkulerande färger</p> <p>Bredd 19 mm Med årtalstryck</p> <p>..07 mörkblå ..08 orange ..09 svart ..10 gul</p> <p>1000 st/rulle 8911 27..</p>		280:-/rl

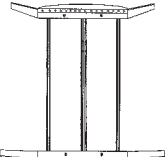
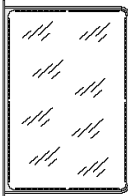
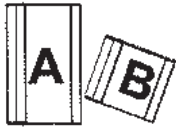

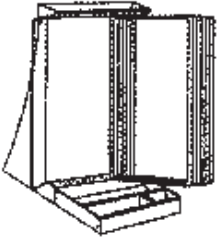

	Benämning	Bestnr	Pris																														
	<p>FÄRGMARKERINGSSYSTEM ColorTab Självhäftande signaletiketter av filmöverdragen färgad kartong för markering på journal- eller arkivmappar Varje bokstav/siffra har sin egen färg</p> <p>Alfabetisk färgetikett A-Ö för vertikal applikation på akter/mappar Höjd 25,5 mm (x38 mm utvikt) 13 färger</p> <table border="0"> <tr><td>..01 A</td><td>..11 K</td><td>..21 U</td></tr> <tr><td>..02 B</td><td>..12 L</td><td>..22 V</td></tr> <tr><td>..03 C</td><td>..13 M</td><td>..23 W</td></tr> <tr><td>..04 D</td><td>..14 N</td><td>..24 X</td></tr> <tr><td>..05 E</td><td>..15 O</td><td>..25 Y</td></tr> <tr><td>..06 F</td><td>..16 P</td><td>..26 Z</td></tr> <tr><td>..07 G</td><td>..17 Q</td><td>..27 Å</td></tr> <tr><td>..08 H</td><td>..18 R</td><td>..28 Ä</td></tr> <tr><td>..09 I</td><td>..19 S</td><td>..29 Ö</td></tr> <tr><td>..10 J</td><td>..20 T</td><td></td></tr> </table> <p>100 st/fp..... 8902 21.. 500 st/rulle..... 8911 21..</p>	..01 A	..11 K	..21 U	..02 B	..12 L	..22 V	..03 C	..13 M	..23 W	..04 D	..14 N	..24 X	..05 E	..15 O	..25 Y	..06 F	..16 P	..26 Z	..07 G	..17 Q	..27 Å	..08 H	..18 R	..28 Ä	..09 I	..19 S	..29 Ö	..10 J	..20 T		<p>60:-/fp 158:-/rl</p>	
..01 A	..11 K	..21 U																															
..02 B	..12 L	..22 V																															
..03 C	..13 M	..23 W																															
..04 D	..14 N	..24 X																															
..05 E	..15 O	..25 Y																															
..06 F	..16 P	..26 Z																															
..07 G	..17 Q	..27 Å																															
..08 H	..18 R	..28 Ä																															
..09 I	..19 S	..29 Ö																															
..10 J	..20 T																																
	<p>Grundsats "1000 Vertikal" Förpackad i 5 st 2-punkts plastmappar med rubrikremsor Statistiskt beräknad sats A-Ö etiketter för markering av 1000 st journaler med 2 bokstäver för efternamn och 1 bokstav för förnamn (Begär särskild information angående funktion)</p> <p>Totalt 3519 bokstäver 8902 2151</p> <p>Vid komplettering av grundsats "1000 V" beställ 902 21..</p>	<p>1.525:-/sts</p>																															
	<p>Numerisk färgetikett 0-9 för vertikal applikation på akter/mappar</p> <p>Höjd 25,4 mm (x38 mm utvikt) 10 färger Ange önskad siffra i slutet av best nr</p> <p>100 st/fp..... 8902 100. 500 st/rulle..... 8911 100.</p>	<p>60:-/fp 158:-/rl</p>																															

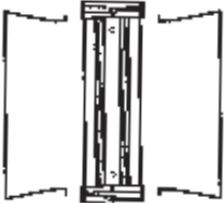
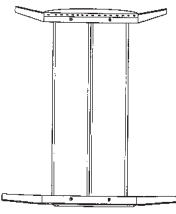
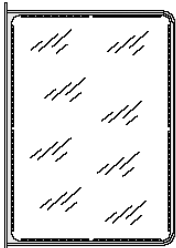
	Benämning	Bestnr	Pris															
	<p>Färgetikett I för applikation på akter/mappar</p> <p>Höjd 7,94 mm (x38 mm utvikt) 14 färger</p> <table border="0"> <tr> <td>..01 grön</td> <td>..06 ljusblå</td> <td>..14 lila</td> </tr> <tr> <td>..02 gul</td> <td>..07 blå</td> <td>..16 lindgrön</td> </tr> <tr> <td>..03 rosa</td> <td>..08 vit</td> <td>..17 brun</td> </tr> <tr> <td>..04 orange</td> <td>..09 grå</td> <td>..24 guld</td> </tr> <tr> <td>..05 röd</td> <td>..11 svart</td> <td></td> </tr> </table> <p>2000 st/rulle 8912 34..</p>	..01 grön	..06 ljusblå	..14 lila	..02 gul	..07 blå	..16 lindgrön	..03 rosa	..08 vit	..17 brun	..04 orange	..09 grå	..24 guld	..05 röd	..11 svart			372:-/rl
	..01 grön	..06 ljusblå	..14 lila															
	..02 gul	..07 blå	..16 lindgrön															
..03 rosa	..08 vit	..17 brun																
..04 orange	..09 grå	..24 guld																
..05 röd	..11 svart																	
<p>Färgetikett II för applikation på akter/mappar</p> <p>Höjd 12,7 mm (x38 mm utvikt) 14 färger</p> <table border="0"> <tr> <td>..01 grön</td> <td>..06 ljusblå</td> <td>..14 lila</td> </tr> <tr> <td>..02 gul</td> <td>..07 blå</td> <td>..16 lindgrön</td> </tr> <tr> <td>..03 rosa</td> <td>..08 vit</td> <td>..17 brun</td> </tr> <tr> <td>..04 orange</td> <td>..09 grå</td> <td>..24 guld</td> </tr> <tr> <td>..05 röd</td> <td>..11 svart</td> <td></td> </tr> </table> <p>1000 st/rulle 8912 35..</p>	..01 grön	..06 ljusblå	..14 lila	..02 gul	..07 blå	..16 lindgrön	..03 rosa	..08 vit	..17 brun	..04 orange	..09 grå	..24 guld	..05 röd	..11 svart			249:-/rl	
..01 grön	..06 ljusblå	..14 lila																
..02 gul	..07 blå	..16 lindgrön																
..03 rosa	..08 vit	..17 brun																
..04 orange	..09 grå	..24 guld																
..05 röd	..11 svart																	
<p>Färgetikett III för applikation på akter/mappar</p> <p>Höjd 25,4 mm (x38 mm utvikt) 14 färger</p> <table border="0"> <tr> <td>..01 grön</td> <td>..06 ljusblå</td> <td>..14 lila</td> </tr> <tr> <td>..02 gul</td> <td>..07 blå</td> <td>..16 lindgrön</td> </tr> <tr> <td>..03 rosa</td> <td>..08 vit</td> <td>..17 brun</td> </tr> <tr> <td>..04 orange</td> <td>..09 grå</td> <td>..24 guld</td> </tr> <tr> <td>..05 röd</td> <td>..11 svart</td> <td></td> </tr> </table> <p>100 st/fp..... 8902 11..</p>	..01 grön	..06 ljusblå	..14 lila	..02 gul	..07 blå	..16 lindgrön	..03 rosa	..08 vit	..17 brun	..04 orange	..09 grå	..24 guld	..05 röd	..11 svart			72:-/fp	
..01 grön	..06 ljusblå	..14 lila																
..02 gul	..07 blå	..16 lindgrön																
..03 rosa	..08 vit	..17 brun																
..04 orange	..09 grå	..24 guld																
..05 röd	..11 svart																	
	<p>VAKANSSKORT Zippel A4 kartong med upphängning, utskjuten flik samt plats för anteckningar</p> <p>Till transparent mapp 668 62... (33), (51), (67–69)</p> <table border="0"> <tr> <td>..02 gul</td> <td>..04 orange</td> </tr> <tr> <td>..05 röd</td> <td>..07 blå</td> </tr> </table> <p>Utv 290x185 mm 25 st/fp 8668 55..</p>	..02 gul	..04 orange	..05 röd	..07 blå		6:90/st											
	..02 gul	..04 orange																
	..05 röd	..07 blå																
<p>Till transparent mapp 668 62... (01–15) (61) Färg: orange</p> <p>Utv 290x185 mm 25 st/fp 8668 5804</p>		6:90/st																
<p>Vakanskort A4 kartong utan upphängning, med utskjuten flik</p> <table border="0"> <tr> <td>..01 grön</td> <td>..02 gul</td> <td>..05 röd</td> </tr> </table> <p>Utv 335x220 mm 25 st/fp 8668 54..</p>	..01 grön	..02 gul	..05 röd		5:90/st													
..01 grön	..02 gul	..05 röd																

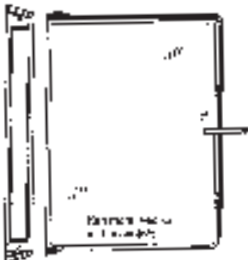

	Benämning	Bestnr	Pris
	<p>Kantskydd I transparent självhäftande film för t ex reparation av söndriga akter/mappar, eller för "inbakning" av lösa etiketter</p> <p>Höjd 51 mm (x47 mm utvikt) 1000 st/fp 8668 8486</p> <p>Kantskydd II</p> <p>Höjd 88 mm (x47 mm utvikt) 500 st/fp 8668 8385</p> <p>Kantskydd III</p> <p>Höjd 102 mm (x47 mm utvikt) 500 st/fp 8668 8485</p>		
	<p>FÖRVARINGSTILLBEHÖR ColorTab färgmarkering</p> <p>Bordställ för förvaring av 2-punktsupphängda plastmappar med 6 toppmatade kanaler</p> <p>Längd 335 mm Bredd 170 mm Höjd 255 mm Kapacitet 165 mm = 25 st mappar Materia: stål Färg: antikvit 8666 2000</p>		
	<p>Back, bärbar för förvaring av ColorTab rullar</p> <p>Längd 483 mm Bredd 147 mm Höjd 100 mm Kapacitet 10 rullar</p> <p>Material: stål Färg: antikvit 8911 2010</p>		
	<p>Mapp A4 transparent 2-punktsupphängd med 6 toppmatade kanaler</p> <p>Ingår i Grundsats : "1000 Vertikal/Horisontal" "1500 Vertikal/Horisontal" Datumsystem 1-31</p> <p>Utv 325x255 mm 8666 5420</p>		
	<p>Rubrikremsor ColorTab i färg för 2-punktsupphängda plastmappar</p> <p>Rubrikremsor A-Ö, vertikal applikation Avsedd för 902 21.. serien. 5 remsor 8666 5454</p> <p>Rubrikremsor 1-31, vertikal applikation Avsedd för 902 24.. serien. 6 remsor 8666 5451</p> <p>Rubrikremsor 00-99, vertikal applikation 17 remsor 8666 5450</p>		

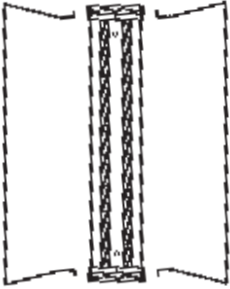
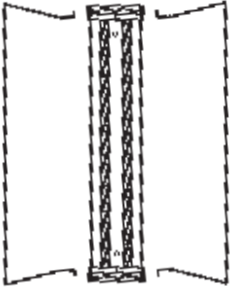
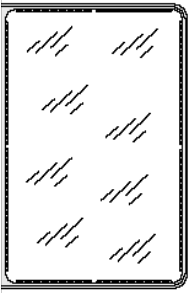
	Benämning	Bestnr	Pris
	A5 InfoFlex SNABBREGISTER ljusgrå BORDSTÄLL METALL A5 Kapacitet 12 ramar..... 8629 5130 Kapacitet 24 ramar..... 8629 5250	350:-/st 370:-/st	
	KOMPLETT FÖRPACKNING A5 1 st bordställ i metall för 12 ramar + 12 st lj.grå ramar..... 8629 5139	575:-/fp	
	VÄGGSTÄLL ALUMINIUM A5 Kapacitet 12 ramar..... 8629 0512 Kapacitet 24 ramar..... 8629 0524 Kapacitet 36 ramar..... 8629 0536 Ramstöd A5 Ø 3 mm..... 8629 0057	73:-/st 85:-/st 110:-/st 8:-/st	
	VÄGGSTÄLL PLAST A5 Kapacitet 4 ramar..... 8629 5040 Kapacitet 12 ramar..... 8629 5120 Kapacitet 24 ramar..... 8629 5240 KOMPLETT FÖRPACKNING A5 1 st väggställ i plast för 12 ramar + 12 st lj.grå ramar..... 8629 5129	28:-/st 52:-/st 85:-/st 260:-/fp	
	RAMAR/BLÄDDERFICKOR A5 Grön 20 st/fp..... 8629 0501 Gul 20 st/fp..... 8629 0502 Röd 20 st/fp..... 8629 0505 Blå 20 st/fp..... 8629 0507 Vit 20 st/fp..... 8629 0508 Lj.grå 20 st/fp 8629 0509	21:-/st 21:-/st 21:-/st 21:-/st 21:-/st 17:50/st	
	REGISTERFLIKAR-INSTICK Registerflik 25 mm 10 st/fp 8625 1231 Instick till dito otryckta, 1 ark om 30 instick..... 8625 1232 Instick till dito med tryck A-Ö, 1 ark 8625 1233 Registerflik 50 mm 10 st/fp 8625 1251 Instick till dito otryckta, 1 ark om 32 instick..... 8625 1252 Instick till dito med tryck A-Ö, 1 ark 8625 1253	34:-/fp 5:50/ark 6:60/ark 37:-/fp 6:-/ark 7:-/ark	
	KOMPLETT VÄGGSTÄLL A5, 6-pack I låst läge, parallellt med vägg. V- eller H-montering Exempelvis utmärkt för montering i skåp eller liknande 1 st väggställ av plast för 6 ramar 6 st ramar i sorterade färger 1 st låsclips..... 8629 0158	185:-/fp	

	Benämning	Bestnr	Pris
	A4 InfoFlex SNABBREGISTER ljust grå BORDSTÄLL PLAST A4 Utv mm H 385 B 245 D 257 Kapacitet 40 ramar..... 8629 0030	255:-/st	
	BORDSTÄLL METALL A4 Kapacitet 12 ramar..... 8629 4130 Kapacitet 24 ramar..... 8629 4250 KOMPLETT FÖRPACKNING A4 1 st bordställ i metall för 12 ramar + 12 st lj.grå ramar 8629 4139	370:-/st 390:-/st	
	VÄGGSTÄLL ALUMINIUM A4 Kapacitet 12 ramar..... 8629 0412 Kapacitet 24 ramar..... 8629 0424 Kapacitet 36 ramar..... 8629 0436 Ramstöd A4 Ø 3 mm..... 8629 0047	88:-/st 130:-/st 176:-/st 8:-/st	
	VÄGGSTÄLL PLAST A4 Kapacitet 4 ramar..... 8629 4040 Kapacitet 12 ramar..... 8629 4120 Kapacitet 24 ramar..... 8629 4240 KOMPLETT FÖRPACKNING A4 1 st väggställ i plast för 12 ramar + 12 st lj.grå ramar..... 8629 4129	30:-/st 54:-/st 90:-/st	
	RAMAR/BLÄDDERFICKOR A4 Grön 20 st/fp..... 8629 0101 Gul 20 st/fp..... 8629 0102 Röd 20 st/fp..... 8629 0105 Blå 20 st/fp..... 8629 0107 Vit 20 st/fp..... 8629 0108 Lj.grå 20 st/fp 8629 0109	29:-/st 29:-/st 29:-/st 29:-/st 29:-/st 24:-/st	
	REGISTERFLIKAR-INSTICK Registerflik 25 mm 10 st/fp..... 8625 1231 Instick till dito otryckta, 1 ark om 30 instick..... 8625 1232 Instick till dito med tryck A-Ö, 1 ark..... 8625 1233 Registerflik 50 mm 10 st/fp..... 8625 1251 Instick till dito otryckta, 1 ark om 32 instick..... 8625 1252 Instick till dito med tryck A-Ö, 1 ark..... 8625 1253	34:-/fp 5:50/ark 5:50/ark 37:-/fp 6:50/ark 6:50/ark	
	KOMPLETT VÄGGSTÄLL A4, 6-pack I låst läge, parallellt med vägg. V- eller H-montering Exempelvis utmärkt för montering i skåp eller liknande 1 st väggställ av plast för 6 ramar 6 st ramar i sorterade färger 1 st låsclips..... 8629 0148 Dito med 6 st ljust grå ramar 8629 0149	210:-/fp 180:-/fp	

	Benämning	Bestnr	Pris
	A3 InfoFlex SNABBREGISTER ljusgrå BORDSTÄLL METALL A3 med fasta sidostöd Kapacitet 10 ramar..... 8629 3110 Kapacitet 30 ramar..... 8629 3310 Kapacitet 50 ramar..... 8629 3510		
	VÄGGSTÄLL METALL A3 Kapacitet 10 ramar..... 8629 3100	8629 3100	390:-/st 535:-/st 864:-/st
	VÄGGSTÄLL ALUMINIUM A3 Kapacitet 8 ramar 8629 0388	8629 0388	76:-/st
	RAMSTÖD Förstärkta A3 Ø 5 mm..... 8629 0038	8629 0038	93:-/st
	RAMAR/BLÄDDERFICKOR A3 Grön 10 st/fp..... 8629 0301 Gul 10 st/fp..... 8629 0302 Röd 10 st/fp..... 8629 0305 Blå 10 st/fp..... 8629 0307 Vit 10 st/fp..... 8629 0308 Lj.grå 10 st/fp 8629 0309		16:-/st
	REGISTERFLIKAR/INSTICK Registerflik 25 mm 10 st/fp 8625 1231 Instick till dito otryckta, 1 ark om 30 instick..... 8625 1232 Instick till dito med tryck A-Ö, 1 ark..... 8625 1233 Registerflik 50 mm 10 st/fp 8625 1251 Instick till dito otryckta, 1 ark om 32 instick..... 8625 1252 Instick till dito med tryck A-Ö, 1 ark..... 8625 1253		48:-/st 48:-/st 48:-/st 48:-/st 48:-/st 41:-/st
			34:-/fp 5:50/ark 5:50/ark 37:-/fp 6:50/ark 6:50/ark

Benämning	Bestnr	Pris
MODUL 4	Planeringssystem T-kort av kartong, 5 storlekar, 10 färger	
MODUL 3		Val-Rex
MODUL 2		
MODUL 1		
MODUL 3 P		
MODUL 1,5 P	T-kort i naturlig storlek	

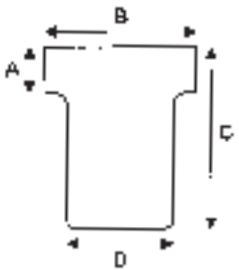
	Benämning	Bestnr	Pris																																										
	PLANERINGSTAVLA T-kort väggmodell Byggbart modulsystem för planering med T-kort i 5 storlekar, 10 färger. Material: stål Färg: ljusgrå Modul 1																																												
	<table border="0"> <thead> <tr> <th>Mått mm</th> <th>Slitsar</th> <th>Höjd</th> <th>Bredd</th> <th></th> <th></th> </tr> </thead> <tbody> <tr> <td>Modul 1/32</td> <td>32 st</td> <td>660</td> <td>31</td> <td>8480 1032</td> <td>89:-/st</td> </tr> <tr> <td>1/54</td> <td>54 st</td> <td>960</td> <td>31</td> <td>8480 1054</td> <td>113:-/st</td> </tr> </tbody> </table>	Mått mm	Slitsar	Höjd	Bredd			Modul 1/32	32 st	660	31	8480 1032	89:-/st	1/54	54 st	960	31	8480 1054	113:-/st																										
	Mått mm	Slitsar	Höjd	Bredd																																									
	Modul 1/32	32 st	660	31	8480 1032	89:-/st																																							
	1/54	54 st	960	31	8480 1054	113:-/st																																							
Modul 1,5 <table border="0"> <thead> <tr> <th>Modul</th> <th>Slitsar</th> <th>Höjd</th> <th>Bredd</th> <th></th> <th></th> </tr> </thead> <tbody> <tr> <td>Modul 1,5/32</td> <td>32 st</td> <td>660</td> <td>48</td> <td>8480 1532</td> <td>114:-/st</td> </tr> <tr> <td>1,5/54</td> <td>54 st</td> <td>960</td> <td>48</td> <td>8480 1554</td> <td>143:-/st</td> </tr> </tbody> </table>	Modul	Slitsar	Höjd	Bredd			Modul 1,5/32	32 st	660	48	8480 1532	114:-/st	1,5/54	54 st	960	48	8480 1554	143:-/st																											
Modul	Slitsar	Höjd	Bredd																																										
Modul 1,5/32	32 st	660	48	8480 1532	114:-/st																																								
1,5/54	54 st	960	48	8480 1554	143:-/st																																								
Modul 2 <table border="0"> <thead> <tr> <th>Modul</th> <th>Slitsar</th> <th>Höjd</th> <th>Bredd</th> <th></th> <th></th> </tr> </thead> <tbody> <tr> <td>Modul 2/32</td> <td>32 st</td> <td>660</td> <td>63</td> <td>8480 2032</td> <td>140:-/st</td> </tr> <tr> <td>2/54</td> <td>54 st</td> <td>960</td> <td>63</td> <td>8480 2054</td> <td>165:-/st</td> </tr> </tbody> </table>	Modul	Slitsar	Höjd	Bredd			Modul 2/32	32 st	660	63	8480 2032	140:-/st	2/54	54 st	960	63	8480 2054	165:-/st																											
Modul	Slitsar	Höjd	Bredd																																										
Modul 2/32	32 st	660	63	8480 2032	140:-/st																																								
2/54	54 st	960	63	8480 2054	165:-/st																																								
Modul 3 <table border="0"> <thead> <tr> <th>Modul</th> <th>Slitsar</th> <th>Höjd</th> <th>Bredd</th> <th></th> <th></th> </tr> </thead> <tbody> <tr> <td>Modul 3/32</td> <td>32 st</td> <td>660</td> <td>95</td> <td>8480 3033</td> <td>160:-/st</td> </tr> <tr> <td>3/54</td> <td>54 st</td> <td>960</td> <td>95</td> <td>8480 3053</td> <td>193:-/st</td> </tr> </tbody> </table>	Modul	Slitsar	Höjd	Bredd			Modul 3/32	32 st	660	95	8480 3033	160:-/st	3/54	54 st	960	95	8480 3053	193:-/st																											
Modul	Slitsar	Höjd	Bredd																																										
Modul 3/32	32 st	660	95	8480 3033	160:-/st																																								
3/54	54 st	960	95	8480 3053	193:-/st																																								
	Modul 4 <table border="0"> <thead> <tr> <th>Modul</th> <th>Slitsar</th> <th>Höjd</th> <th>Bredd</th> <th></th> <th></th> </tr> </thead> <tbody> <tr> <td>Modul 4/32</td> <td>32 st</td> <td>660</td> <td>127</td> <td>8480 4032</td> <td>163:-/st</td> </tr> <tr> <td>4/54</td> <td>54 st</td> <td>960</td> <td>127</td> <td>8480 4054</td> <td>214:-/st</td> </tr> </tbody> </table>	Modul	Slitsar	Höjd	Bredd			Modul 4/32	32 st	660	127	8480 4032	163:-/st	4/54	54 st	960	127	8480 4054	214:-/st																										
	Modul	Slitsar	Höjd	Bredd																																									
Modul 4/32	32 st	660	127	8480 4032	163:-/st																																								
4/54	54 st	960	127	8480 4054	214:-/st																																								
	Tvärlist till kortbärare <table border="0"> <thead> <tr> <th>Mått mm</th> <th>Längd</th> <th>Höjd</th> <th>Bredd</th> <th></th> <th></th> </tr> </thead> <tbody> <tr> <td>Modul 5</td> <td>162</td> <td>30</td> <td>15</td> <td>8480 0569</td> <td>360:-/par</td> </tr> <tr> <td>10</td> <td>322</td> <td>30</td> <td>15</td> <td>8480 0570</td> <td>383:-/par</td> </tr> <tr> <td>12</td> <td>388</td> <td>30</td> <td>15</td> <td>8480 0573</td> <td>406:-/par</td> </tr> <tr> <td>15</td> <td>481</td> <td>30</td> <td>15</td> <td>8480 0571</td> <td>443:-/par</td> </tr> <tr> <td>20</td> <td>645</td> <td>30</td> <td>15</td> <td>8480 0572</td> <td>499:-/par</td> </tr> <tr> <td>24</td> <td>772</td> <td>30</td> <td>15</td> <td>8480 0574</td> <td>574:-/par</td> </tr> </tbody> </table>	Mått mm	Längd	Höjd	Bredd			Modul 5	162	30	15	8480 0569	360:-/par	10	322	30	15	8480 0570	383:-/par	12	388	30	15	8480 0573	406:-/par	15	481	30	15	8480 0571	443:-/par	20	645	30	15	8480 0572	499:-/par	24	772	30	15	8480 0574	574:-/par		
	Mått mm	Längd	Höjd	Bredd																																									
Modul 5	162	30	15	8480 0569	360:-/par																																								
10	322	30	15	8480 0570	383:-/par																																								
12	388	30	15	8480 0573	406:-/par																																								
15	481	30	15	8480 0571	443:-/par																																								
20	645	30	15	8480 0572	499:-/par																																								
24	772	30	15	8480 0574	574:-/par																																								
T-kort planeringskort till kortbärare Av kartong, 10 färger, 100 st/fp ..01 grön ..02 gul ..03 rosa ..04 orange ..05 röd ..07 blå ..08 vit ..09 grå ..14 lila ..18 beige Ange färgnr i best nr																																													
<table border="0"> <thead> <tr> <th>Mått mm</th> <th>A</th> <th>B</th> <th>C</th> <th>D</th> <th></th> <th></th> </tr> </thead> <tbody> <tr> <td>Modul 1</td> <td>15</td> <td>28</td> <td>49</td> <td>16</td> <td>8480 49..</td> <td>46:-/fp</td> </tr> <tr> <td>2</td> <td>15</td> <td>60</td> <td>84</td> <td>49</td> <td>8480 50..</td> <td>53:-/fp</td> </tr> <tr> <td>3</td> <td>15</td> <td>92</td> <td>118</td> <td>80</td> <td>8480 51..</td> <td>71:-/fp</td> </tr> <tr> <td>4</td> <td>15</td> <td>124</td> <td>178</td> <td>112</td> <td>8480 52..</td> <td>111:-/fp</td> </tr> </tbody> </table>	Mått mm	A	B	C	D			Modul 1	15	28	49	16	8480 49..	46:-/fp	2	15	60	84	49	8480 50..	53:-/fp	3	15	92	118	80	8480 51..	71:-/fp	4	15	124	178	112	8480 52..	111:-/fp										
Mått mm	A	B	C	D																																									
Modul 1	15	28	49	16	8480 49..	46:-/fp																																							
2	15	60	84	49	8480 50..	53:-/fp																																							
3	15	92	118	80	8480 51..	71:-/fp																																							
4	15	124	178	112	8480 52..	111:-/fp																																							
T-kort till pärm och kortbärare <table border="0"> <tbody> <tr> <td>Modul 1,5 P</td> <td>15</td> <td>45</td> <td>52</td> <td>36</td> <td>8480 55..</td> <td>49:-/fp</td> </tr> <tr> <td>3 P</td> <td>15</td> <td>92</td> <td>60</td> <td>80</td> <td>8480 56..</td> <td>63:-/fp</td> </tr> </tbody> </table>	Modul 1,5 P	15	45	52	36	8480 55..	49:-/fp	3 P	15	92	60	80	8480 56..	63:-/fp																															
Modul 1,5 P	15	45	52	36	8480 55..	49:-/fp																																							
3 P	15	92	60	80	8480 56..	63:-/fp																																							

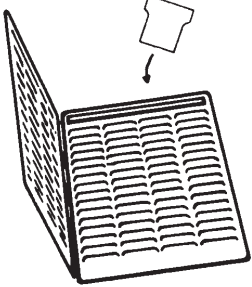
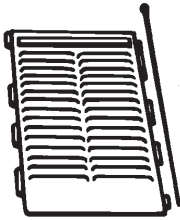
	Benämning	Bestnr	Pris
	<p>T-kort modul 3 transparent plast med fönsterflik för instick 95x18 mm samt ficka för A7 skrivkort 100 st/fp..... 8480 3077</p> <p>Instick i ark till T-kort av plast ..01 grön ..05 röd 500 st/fp..... 8480 30..</p> <p>Skrivkort till T-kort av plast, otryckta 105x74 mm (A7) 100 st/fp..... 8622 8002</p>	<p>430:-/fp</p> <p>117:-/fp</p> <p>18:-/fp</p>	
	<p>PLANERINGSPÄRM för T-kort (P) Kopieringsbar 2-sidig plastpärm i A4 format för planering med T-kort Obegränsat påbyggbar med extra mellansidor Färg: svart</p> <p>Planeringspärm V+H sida 2x4 rader för T-kort modul 1,5 P (64 slitsar per sida) 128 slitsar totalt 8480 0700</p> <p>2x2 rader V+H sida för T-kort modul 3 P (30 slitsar per sida) 60 slitsar totalt..... 8480 0710</p>	<p>338:-/st</p> <p>332:-/st</p>	
	<p>Mellansida 4-radig för T-kort modul 1,5 P 64 slitsar totalt..... 8480 0701</p>	<p>172:-/st</p>	